

TRUMP in the field of Medical industry

----- Medical imaging system

Medical Diagnostic X-Ray System

CONTENT

TRUMP 001	30ma X-Ray Mobile Machine	2
TRUMP 002	50ma X-Ray Mobile Machine	2
TRUMP 003	100ma X-Ray Mobile Machine	3
TRUMP 004	The medical diagnostic X-ray unit 200mA	4
TRUMP 005	The medical diagnostic X-ray unit 300mA	8
TRUMP 006	The medical diagnostic X-ray unit 500mA.....	12
TRUMP 007	The High frequency radiography system 50kw-CE*.....	17
TRUMP 008	The High frequency remote-controlled X-ray unit (80kW)	19
TRUMP 009	The remote controlled diagnostic X-ray unit (500mA)-CE*.....	26
TRUMP 010	The Mobile series C-arm X-ray Unit.....	28
TRUMP 011	The high frequency mobile X-ray unit	29
TRUMP 012	The new advanced digital radiography system(DR system)	30
TRUMP 013	Low-Intensity Portable X-Ray Imaging Scope	33
TRUMP 014	Portable & high frequency medical diagnosis X-ray machine	38
TRUMP1	For people use	38
TRUMP2	For animal special use.....	42
Automatic film processor-CE.....		44
TRUMP 015	Dental x-ray unit	46
TRUMP1-	Micro focus Dental x-ray unit.....	46
TRUMP2-	HIGH FREQUENCY DENTAL X-RAY UNIT	49
TABLE-TOP	DARKROOM.....	51
TRUMP 016	ORAL PANORAMIC X-RAY UNIT	51
TRUMP 017	Mammography machine	53
Set of accessories for X-RAY room use		55
X-RAY film illuminator		55
X-RAY RADIOGRAPHIC CASSETTE.....		56
Medical Computer Interphone System		57
X-ray Film Hanger		57
X-ray Film Safety Light		58
Chart Light Box.....		58
Intensifying Screen		59
Container For Film Development.....		59
Radiation protection series		60

TRUMP 001

30ma X-Ray Mobile Machine

Brief introduction

- Used in ward and emergency treatment room for fluoroscopy and radiog
- Combined X-RAY generator
- Single focus, full wave rectification
- It is precise, safe, reliable and flexile
- Remote control device (control range \geq 5 m) is used



TRUMP 002

50ma X-Ray Mobile Machine

Brief introduction

- This X-ray apparatus features fullwave rectification and mod
- The frame of the unit, of cantilever construction, is compact i
- The machine can be used for radiography in hospital wards (



Technical indexes

- Maximum ratings

	S				
kv	0.08-1	2-2.5	3.2-4.0	5.0-6.3	
m mA					
30	90	90	90	90	
40	90	90	90	/	
50	90	80	/	/	

- Power requirements:
 - ⚡ Voltage:180-240V Frequency:50Hz
 - ⚡ Internal resistance: $\leq 1\Omega$ Rating:5k VA
 - ⚡ Current:Maimum15A for radiography
- Time:0.08 to 6.32 steps electronic
- Maximum height from X-ray tube focus to floor $>$ 1820mm

-
- Minimum height from X-ray tube focus to floor<550mm
 - Collimator:Maximum film size at 1000mm
 - Focal distance: 430×430mm
 - Maximum remote control distance:6m
 - X-ray tube focus:2.3×2.3
 - Unit moving force: <5kg
 - Net weight of the unit:90kg

TRUMP 003

100ma X-Ray Mobile Machine

Brief introduction

- 100Ma X-Ray Mobile Machine
- Take x-ray photography of the head, extremities, chest cavity and other
- In the ward or in operation room.

Features

- Single focus, full-wave rectifier, combined X-ray generator
- SCM control (easy to maintain and repair)
- High visual and operational console with LCD monitor
- Prestore 8 kinds of photography parameters and select, modify, store the parameters under the condition of choice
- Power voltage (V), photograph kilovolt (KV) infinitely variable control
- Premier high voltage with high power SCR zero control circuit
- Function of load chains, exposure time control, auto alarm, preheat filament, subassemblies temperature control, and so on Cantilever structure makes the small volume and easily moving



Technical indexes

- Power supply:
 - ⚡ Voltage: 180-240 V
 - ⚡ Frequency: 50HZ

-
- ✚ Internal resistivity <math><1.0\Omega</math>
 - ✚ Current 35A instant
 - ✚ Rating $\geq 7k\text{ VA}$
 - Photography:
 - ✚ Voltage: 50-100 kV
 - ✚ current 16ma. 32ma 63ma 100ma
 - ✚ time 0.08s ~6.3s
 - ✚ X-ray tube focus 4.3mm X4.3mm
 - Maximum remote control distance: 7m
 - Maximum height of focal spot from floor>1880 mm
 - Minimum height of focal spot from floor <math><520\text{ mm}</math>
 - Columns turning angle: ± 45
 - Collimator: maximum film size at 650mm focal distance: 350 mm X 350 mm
 - The net weight of the unit: 150kg gross Weight: 240kg
 - Shipping volume: 150cm X 100cm X 150cm

Focus of X-ray tube	Photograph Current (mA)	Max photograph voltage (kvp)	Max allowable exposure time
Big focus	16	90	6.3
	32	90	6.3
	63	85	4.2
	100	80	3.0

TRUMP 004 **The medical diagnostic X-ray unit 200mA**

This unit can make fluoroscopy, routine radiography, spot film radiography, bucky radiography and linear tomography.

Configuration:

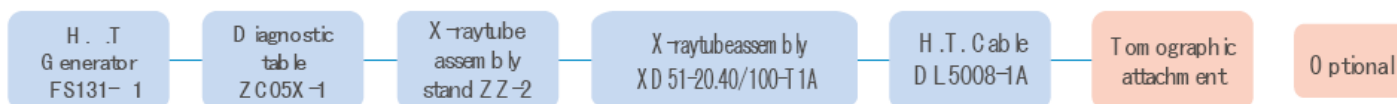

Features:

- One-table, one-tube.
- Single-phase, full wave, high voltage rectification.
- Protective devices for X-ray tube capacity, anode -starting, and exposure timing.
- External-balanced diagnostic table, motor driven table tilting with spring-oscillating bucky under the table.
- Spot film device with self-centering holder for cassettes of different sizes, electromagnetic locks.
- Ceiling-floor rail type tube stand with safety device.
- Linear tomographic attachment can be selected.



Technical specification:

Item	Contents		
Fluoroscopy	0.5 ~ 5mA, 45 ~ 90kV adjustable continuously		
Radiography	Tube voltage	50 ~ 100kV adjustable continuously	
	Tube current	30 ~ 200mA adjustable continuously	
	Exposure time	0.05 ~ 6s 23 steps	
	Table tilting	+90°~0°~ -5°motor-driven	
	Spotfilm device	Movable range	Longitudinal 560mm
			Transverse 80mm
			Compressing 300mm
	Film size	Locking	Electro-magnetic lock
			127×178mm(5 " ×7 ") 254×305mm(10 " ×12 ") 203×254mm(8 " ×10 ") 280×356mm(11 " ×14 ")
	Buck (oscillating type)	Density	N28
Focus		f ₀ 100	
Ratio		r8	
Tabletop-film distance	60mm		
Collimator	Single-leaf manual		

Tube stand	Adjustable range between ceiling and floor:2820 ~ 3185mm	
	Sliding in longitudinal (along ceiling and floor): 1800mm	
	Transversely movement (along rotation arm): 660mm (from focus to center of stand)	
	Vertical movement (along stand): 295 ~ 1800 (from focus to the ground)	
X-ray tube assembly	Model	XD51-20.40/100-T1A
	Focus	1×1mm/ 2×2mm
	Speed	2800r/min
Power supply	Voltage	Single phase 380V/ 220V AC
	Capacity	≥13kVA
	Frequency	50Hz
	Inner resistance	380V: 1Ω 220V: 0.3Ω

Item (optional)	Contents	
Tomographic attachment	Exposure angle	30°~ 60°adjustable
	Layer height	20 ~ 200mm manual

This unit can make fluoroscopy, routine radiography, spot film radiography, bucky radiography and linear tomography.

Configuration:

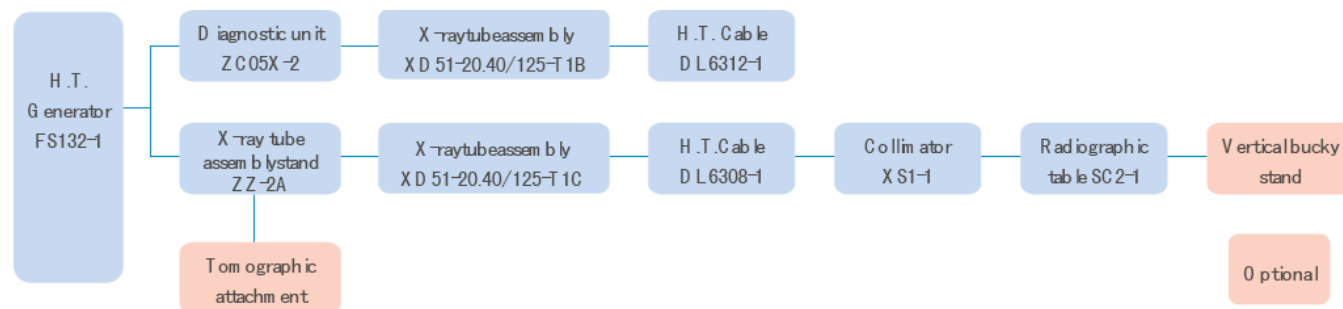

Features:

- Two-table, two-tube.
- Single-phase, full wave, high voltage rectification.
- Protective devices for X-ray tube capacity, anode-starting and exposure timing.
- External-balanced diagnostic table, motor driven table tilting.
- Spot film device with self-centering holder for cassettes of different sizes, electromagnetic locks.
- Radiographic table with spring oscillating bucky.
- Ceiling-floor rail type tube stand with safety device.



- Linear tomographic attachment can be selected.

Technical specifications:

Item	Contents			
Fluoroscopy	0.5 ~ 5mA, 45 ~ 110kV adjustable continuously			
Radiography	Tube voltage	50 ~ 125kV adjustable continuously		
	Tube current	30 ~ 200mA 5 steps		
	Exposure time	0.01 ~ 5s 23 steps		
Diagnostic	Table tilting	+90°~0°~ -5°motor-driven		
	Spotfilm device	Movable range	Longitudinal	560mm
			Transverse	80mm
			Compressing	300mm
	Locking	Electro-magnetic lock		
Film size		127×178mm(5 " ×7 ")	254×305mm(10 " ×12 ")	
		203×254mm(8 " ×10 ")	280×356mm(11 " ×14 ")	
Tube stand	Adjustable range between ceiling and floor:2820 ~ 3185mm			
	Sliding in longitudinal (along ceiling and floor): 1800mm			
	Transversely movement (along rotation arm): 700mm (from focus to center of stand)			
	Vertical movement (along stand): 60~ 1800 (from focus to the ground)			
Radiographic table	Tabletop	Longitudinal: Manual		
	Lock mode	Electron agnetic lock		
	Buck (oscillating type)	Density: N28		
		Focus: f ₀ 100		
Ratio: r8				
X-ray tube assembly	Model	XD51-20.40/125		
	Focus	1×1mm/ 2×2mm		
	Speed	2800r/min		
Power supply	Voltage	Single phase 380V/ 220V AC		
	Frequency	50Hz		
	Inner resistance	380V: 0.9Ω 220V: 0.3Ω		



TRUMP 005

The medical diagnostic X-ray unit 300mA

This unit can make fluoroscopy, routine radiography, spot film radiography, bucky radiography and linear tomography.

Configuration:

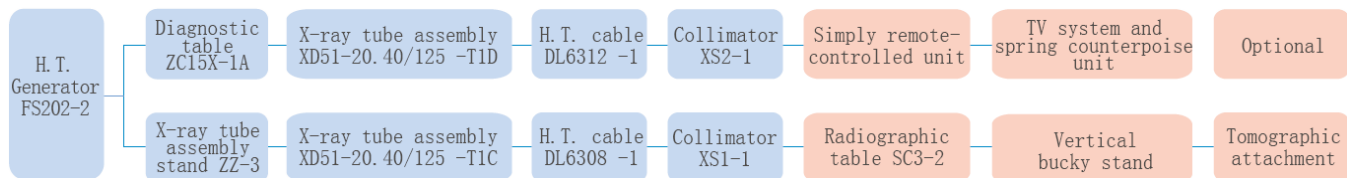

Features:

- Two-table, two-tube.
- Single-phase, full wave, high voltage rectification.
- SCR exposure switch.
- Protective devices for X-ray tube capacity, anode starting and exposure timing.
- Inner-balanced diagnostic table, motor driven table tilting and tabletop moving at head end electrically.
- Spot filming parameters preset on spot film device.
- Spot film device with self-centering holder for cassettes of different sizes, high density stationary grid and electromagnetic locks.
- The tabletop of radiographic table can be moved in longitudinal and transverse direction with oscillating bucky and electromagnetic locks.
- Ceiling-floor rail type tube stand, telescopic rotating tube arm, electromagnetic locks and double-cable safety device.
- Motor-driven multi-leaf collimator for under-table tube and manual multi-leaf collimator with light beam indicator for over-table tube.
- Motor-driven linear tomographic attachment can be selected, layer height adjusted electrically.
- Interface for TV system and vertical bucky stand.



Technical specifications:

Item	Contents			
Fluoroscopy	0.5~5mA, 45~110kV adjustable continuously			
Radiography	Tube voltage	50~125kV adjustable continuously		
	Tube current	25~300mA adjustable continuously		
	Exposure time	0.02~5s adjustable by 23 steps		
Diagnostic table	Table tilting	+90°~0°~- 15° motor-driven		
	Tabletop moving	500mm at head end		
	Spotfilm device	Moveable range	longitudinal	1720mm
			transverse	125mm
			compressing	300mm
	Locking	Electromagnetic lock		
	Bucky	Stationary	Density:	N40
Focus:			f_0 70	
Ratio:			r8	
Film size	127×178mm(5 " ×7 ")	254×305mm(10 " ×12 ")		
	203×254mm(8 " ×10 ")	280×356mm(11 " ×14 ")		
Collimator	Multi-leaf motor-driven			
Tube stand assembly	Adjustable range between ceiling and floor:2650 ~ 3200mm			
	Sliding in longitudinal (along ceiling and floor): 2000mm			
	Sliding in transverse (along rotation arm): 900~1140mm (from focus to center of stand)			
	Up-down movement (along stand): 500~ 1800 (from focus to the ground)			

Item	Contents		
Radiographic table	Moving range of tabletop: Longitudinal: 1200mm Transverse: 200mm		
	Lock mode	Electromagnetic lock	
	Bucky (Oscillating type)	Density:	N40
		Focus:	f_0 70
Ratio:		r8	
Tabletop-film distance	≤80mm		

X-ray tube assembly	Model	XD51-20.40/125
	Focus	1mm/,2mm
	Speed	2800r/min
Power supply	Voltage	Single phase 380V/ 220V AC
	Capacity	≥20kVA
	Frequency	50Hz
	Inner resistance	380V: 0.75Ω 220V: 0.25Ω

Item (optional)	Contents	
Tomographic attachment	Exposure angle	10° 30° 50°three steps
	Layer height	0 ~ 220mm motor-driven
Vertical bucky stand	Height adjustable	
	Bucky tiltable	

TRUMP 005 The medical diagnostic X-ray unit 300mA

- Computer controlled.
- Automatically distinguish line power and frequency, and auto. compensate power fluctuation.
- Assure output precision, improve image quality, simplify operating procession.

Specification:

Improve performance and stability

- Simply operate and steadily output by adopted computerized control.

Self-Diagnosis and Error Code Display

- The system has 23 error codes. Once failure occurs, error code is automatically displayed on the control panel for maintenance.

Auto. Tube Capacity Protection

- Besides 3-point control (kW, mA, Sec), exposure parameters can be set with kV, mAs.
- According to the maximum capacity of tube and minimum exposure time can fix the upper limit of exposure mA and protect the tube.

Preset Exposure Parameters

- The system provides 90 programs, which can be modified, corrected and stored according to exposure position and patient size.



Technique Specification

Standard Composition:
Microprocessor controlled H.T. Generator FS202-3
Diagnostic Table ZC15X-2
Radiographic table SC3-2
X-ray tube stand ZZ-3

Specification:
Power supply: 380V AC±10% single phase
Frequency: 50Hz
Inner resistance: 0.3Ω
Setting range:
Radiography: Tube voltage: 50~125kV
Tube current: 30~300mA
Exposure time: 0.02~5s 23 steps
Fluoroscopy: Tube voltage: 40~110kV
Tube current: 0.5~5mA
Option:
TV system
Vertical bucky stand



TRUMP 006

The medical diagnostic X-ray unit 500mA

Features:

- One-table, one-tube. Single-phase, full-wave, high voltage rectification. High voltage switch on/off with SCR. Protectors for X-ray capacity, anode starting and exposure time. Integrated radiographic table without ceiling-floor railway, makes installation easier. The table top can move longitudinally and transversely with electromagnetic Locks and foot switch controls. X-ray tube assembly can rotate freely and stay at stated position. It can combine with vertical bucky stand

Application:

- The product provided many kinds of selections for customers, It is radiography which can make routine radiography, bucky radiography, linear tomography and tilting radiography.



500mA Full Wave Generator



Generator Technical Specifications:

Generator Output Parameters

Kvp Range	Radiography 50 ~ 125KVp
mA Range	Radiography 30 ~ 500mA by 23 step
Time Range	Radiography 0.02s ~ 5s

Generator Working Conditions

3-Phase Power Supply	380VAC±38VAC
Power Frequency	50Hz±1Hz
Max. power	29.6kW
Internal Resistance of Power Supply	≤0.3Ω
Rating for drain current to ground of leakage protector	20mA electromagnetic type
Ambient Temperature	10℃~40℃;
Relevant Humidity	30%~75%
Atmospheric Pressure	70.0kPa~106.0kPa

Environmental Specification

OPERATING

Ambient Temperature Range	10℃~40℃
Relative Humidity	30%~75%
Atmospheric Pressure Range	70.0kPa~106.0kPa
TRANSPORT AND STORAGE	
Ambient Temperature Range	-40℃~+70℃
Relative Humidity	10%~100% including condensation
Atmospheric Pressure Range	50.0kPa~106.0kPa

X-ray Tubes: XD52-30.50/125- T2A

X-ray Tube Assembly Specification:

X-ray Tubes Assembly : XD52-30.50/125- T2A	
Rated Voltage	125kV
Rated Focal Spot Value	1×1/2×2 mm
Maximum Power	30/50 kW
Lowest ARS (50Hz)	2800r/min
Heat Storage of Tube Assembly	140000HU
Inherent Filtration	3.2 mmAl
Weight (without additional components)	23.5kg

Collimator: XS1-2

XS1-2 is multi-page and adjustable collimators for X-ray radiation field. A rectangular radiation field with a desired size can be produced by adjusting the collimator within a specified range. It is easy to install and to operate. Therefore, this unit can effectively reduce the damage to human bodies caused by X-ray leakage.

Collimators Specification	
	XS1-2
Mode of Adjustment	Manuel
Maximum Tube Voltage	150kV
Radiation Field [Max SID = 100cm]	450×450mm
Radiation Field [Min SID = 100cm]	2×2mm
Time Limit of the Light Source	≤ 30s
Inherent Filtration	2 (mmAl)
External Dimension (length X Width X Height)	250×250×224mm
Weight	9.5kg

Radiographic Table: SC4-1



SC4-1 radiographic table can be used to perform conventional radiography, bucky radiography and oblique radiography. It can also be used together with vertical radiographic stand for chest filming.

SC4-1 Radiographic Table Specification

Tabletop Length	2000mm
Tabletop Width	730mm
Tabletop Height	690mm
Tabletop Movement (Longitudinal)	± 600 mm
Tabletop Movement (lateral)	± 100 mm
X-ray tube assembly Movement (Longitudinal)	580mm
X-ray tube assembly Movement (Vertical)	1100mm
Rotation around lateral arm	+90° ~ -90°
Tabletop Locking	electromagnetically locking
Tabletop Locking Control	footswitch (normally closed)
Bucky Vibration Mode	oscillating

BUCKY SPECIFICATION

Focus	fo=100cm
Grid Ratio	r=8
Grid Density	N=40
Grid Size	14" X 17" (356mm X 432mm)
Film Loaded in Bucky	Max 14" X 17"
Distance between Tabletop and Bucky Film	≤ 80 mm
Longitudinal Travel of Bucky	580mm
Bucky Locking	electromagnetically locking
Power supply	220V, 50Hz
Input Power	0.25 kVA

Vertical Bucky Stand: LS-3(optional)



The apparatus together with various X-ray diagnostic equipments can conduct X-ray radiographic for chest, waist, joints, head, arms and legs of a patient.

LS-3 Technical Specification	
Maximum Dimension	14"x17"
Density of Grid	40 lines/cm
Grid Ratio	10
Vertical Movement	780mm ~ 1850mm
Film Size	20cm x 25cm, 34cm x 43cm
Focusing Distance	fo=150cm
OPERATING CONDITION	
Ambient Temperature	10°C ~ 40°C
Relative Humidity	30% ~ 70%
Atmospheric Pressure	70 ~ 106 kPa

TRUMP 007

The High frequency radiography system 50kw-CE*

Features:

- ·Large LCD displays all radiographic modes.
 - ·Friendly user interface and easy menu design.
 - ·Normal radiography, bucky radiography, tilting radiography,
 - Ion chamber AEC and APR mode can be selected.
 - ·Best radiographic mode ensures high quality image.
 - ·Automatic heat capacity protection.
 - ·The preset parameter can be modified and saved under APR mode.
 - ·New-designed table, displays SID and rotation angle automatically.
 - ·Multi-functional radiography meets clinical requirements.
 - ·High frequency design (25kHz).
 - ·Short exposure time (min 2ms).
 - ·High kV (150kVp), high mA (630mA), small size focus (1mm).
 - ·AEC+APR function.
 - ·Multi-style console installation.
 - ·System upgrade.
- Console on the table/wall or with pedestal
- ·Modularized design.
 - ·Extensive configuration.



Standard Configuration:

- H.T. generator
- H.T. cable 75kV/16m
- X-ray tube assembly Siemens RAY-12
- Radiographic table (including Ion Chamber)
- X-ray tube stand
- Collimator

Option:

- Vertical bucky stand LS-3



Technical Specifications:

Generator	Transformation mode	H.F. inverter type	25kHz
	kVp	1kVp/step	40~150kVp \pm (5%+1kVp)
	mA	By step	25~630mA \pm (5%+1mA)
	Time	By step	2ms~5s \pm (1%+0.1ms)
	mAs	By step	1~500mAs \pm (5%+mAs)
	Max. capacity		50kW
	Power supply	Inner-resistance	
Voltage			3-phase 380V
Capacity			50kVA
X-ray tube assembly	Siemens RAY-12		
H.T. cable	75kV/16m		
Radiographic table	Bucky stand	Tube vertical movement 520~1760mm	
		Tube longitudinal movement along table body 2380mm	
		Tube assembly rotation around lateral arm-120 $^{\circ}$ ~+120 $^{\circ}$ can be fixed at any position	
		Tube stand rotation 0 $^{\circ}$ ~ \pm 90 $^{\circ}$, fixed position at 90 $^{\circ}$	
	Table top	Length 2100mm	
		Width 800mm	
		Height 690mm	
		Longitudinal movement 900mm	
		Transverse movement 250mm	
Collimator	Manual		

High frequency technology IGBT module

High Precision X-ray Control System

- ·Computer Controlled System.
- ·High frequency technology, constant DC output, improved image quality, reduced patient radiation exposure.
- ·IPM IGBT ensuring the reliability.
- ·Real-time, closed-loop control system ensures the high precision of tube kV and mA, and good repeatability.
- ·Precise exposure time as short as 1 ms.

Pulse Fluoro Function

- ·Pulse fluoro can meet the requirements of digital image system. Lower dose, higher image quality.

APR Function

- ·600 memory programs can be chosen and the conditions can be spot defined. It is adjustable to meet the different physician habits.

AEC

- ·Multi-function AEC.
- ·Manual choosing of kVp, mA, and preparation time,
- system auto control exposure time, 3 steps exposure doze.
- ·Many radiography kVp and fluoro kVp formulas can
- be chosen.
- ·Full-automatic mode.
- ·ABC system protect the patient and physician from unnecessary X-ray radiation.
- ·kVp compensation function of auto-exposure voltage
- compensation system can acquire high clarity images of any patient size.
- ·PMT/Ion chambers AEC.
- ·Bucky stand/RAD table can be integrated ion chamber.
- ·The exposure dose can be automatic controlled according to different imaging

Safety-protection Function

- ·Computed-controlled X-ray tube permits
- the load and heat capacity management.

media.



TRUMP 008 The High frequency remote-controlled X-ray unit (80kW)

DIGITAL TOUCH-SCREEN DISPLAY

PERFECT WORK AND FUNCTIONS

SIMPLE AND EASY OPERATION

HIGHLY INCREASED EFFICIENCY

Digital Touch-screen Display

- ·LCD with special system support system makes big improvement in clinical operation. The operation control system is developed to touch-screen.
- ·Radiography parameters can be set by pressing the keys or inputting directly on the screen.
- ·Patient manage functions, ID of the patient, diagnostic position, physician, time, date and notes etc information can be stored.
- ·The X-ray tube heat-capacity diagram is showed directly.

Main Technical Specifications

-
- ·Generator power: 80kW.
 - ·Rad kV:40~150kV, continuous adjustable, 111 steps.
 - ·Rad mA: 10~800mA(1000mA can be chosen).
 - ·Rad time: 1ms~10s.
 - ·Fluoro kV: 40~120kV, continuous adjustable.

High Definition Image

- ·Integrated sensor system with high-assimilation rate.
- ·17" or 21" high resolution medical X-screen.
- ·Small focal spot, high power, high speed X-tube digital control stator.
- ·High resolution multi-field image intensifier.



Economic Table Simple configuration

Easy interface Superb Performance

Special attention is given to the interface of 80kW generator and diagnostic tables to ensure overall system performance. The combined advantages of the generator and the table result in versatility and multiple applications, including gastro-intestinal examination, endoscope bronchography, spinal cord catheterization, angiography and interventional procedures.



Spotfilm device movement
72cm in longitudinal

Large range of spotfilm device movement allows fluoroscopic and radiographic exposures of various positions without patient movement.

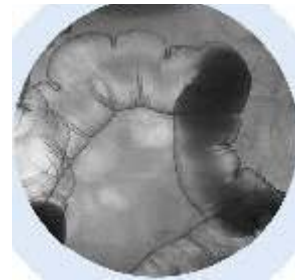
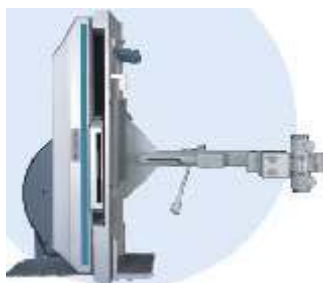

Table tilting at -25°
Table tilting at +90°

Diagnostic table can tilt smoothly from +90°~-25°.It is comfortable for patient.



ZC25SY-2 diagnostic table can do chest radiography , focal distance 1.5m (option)



Integrative linear tomography table SC5-1



Integrative radiography table SC4-4

EXCELLENT OFFER LATEST DEVELOPED CASTELESS, CASSETTE REMOTE CONTROLLED TABLES

90°/-45° Table Tilting

Large negative tilting degree allows radiography of stomach lining.

Fast Radiography Cassetteless Table

The film supply system and receiving system can automatically carry out serial radiography without cassette. 3 film sizes (10" ×12", 11"×14", 14"×14") can be selected. The supply magazine can be loaded up to 50 films. Patient name and number can be printed on the film.



Convenient to Select Fluoro and Rad Position

The radiographic system of such serial spotfilm device can move more than 600cm towards head-end without table top movement to realize a complete radiography for gastro-intestinal examination. Convenient for endoscope bronchography examination during fluoroscopy.

Table Top Movement Suitable for Multipurpose Examination

Such serial diagnostic table top can move 1,500mm longitudinally, suitable for multi-purpose examination and diagnosis.

The digital image processing system

- 12bit Acquisition, Image Quality Is Similar to Film



Swing Radiography

The X-ray tube assembly can swing from +30°~-30°, satisfying special exposure requirement.

Variable Focal Distance

The distance from X-ray tube focus to film can be adjusted at 110cm, 120m, 130cm.

-
- CCD camera, 12 bit acquisition.
 - 4096 grey level.
 - CCD camera (1k×1k), Gamma correction.
 - Image processing, display and saving.

Digital Spot-film Acquisition Speed

- 1024×1024×12 bit single frame.
- 1024×1024×12 bit 0.5-15fps.

Digital Fluoroscopy Acquisition Speed

- 1024×1024×12 bit single frame.
- 1024×1024×12 bit 1-30fps.
- Support various width pulse fluoro.
- 128 frames fluoro loop.

Real-time Image Processing

- 4 level real-time edge enhancement, 7 level
- Notation, 4/16frames on one screen.
- Zooming and mapping.
- Real-time review.
- DICOM 3.0 interface (optional).
- CD-R (optional).
- Laser camera interface.
- Road map display.
- DSA (optional).
- Mask re-setting, background holding.
- (in DSA function optional).



On-site Service Function

- The system with auto on-site service software.
- The software can perform self-diagnosis on the whole
- system or a single board or a single replaceable unit.

OPERATING ROOM DRAWING:

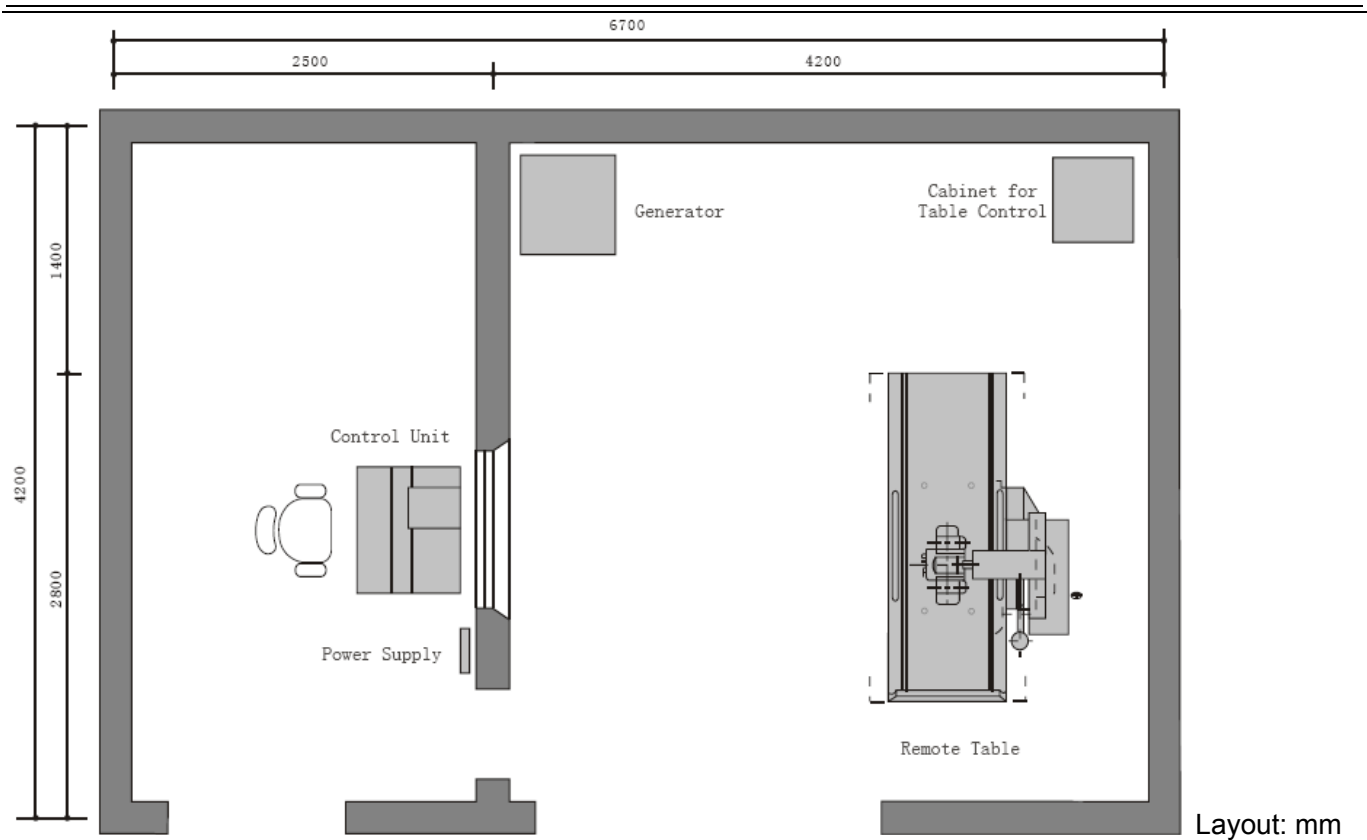

Configuration:

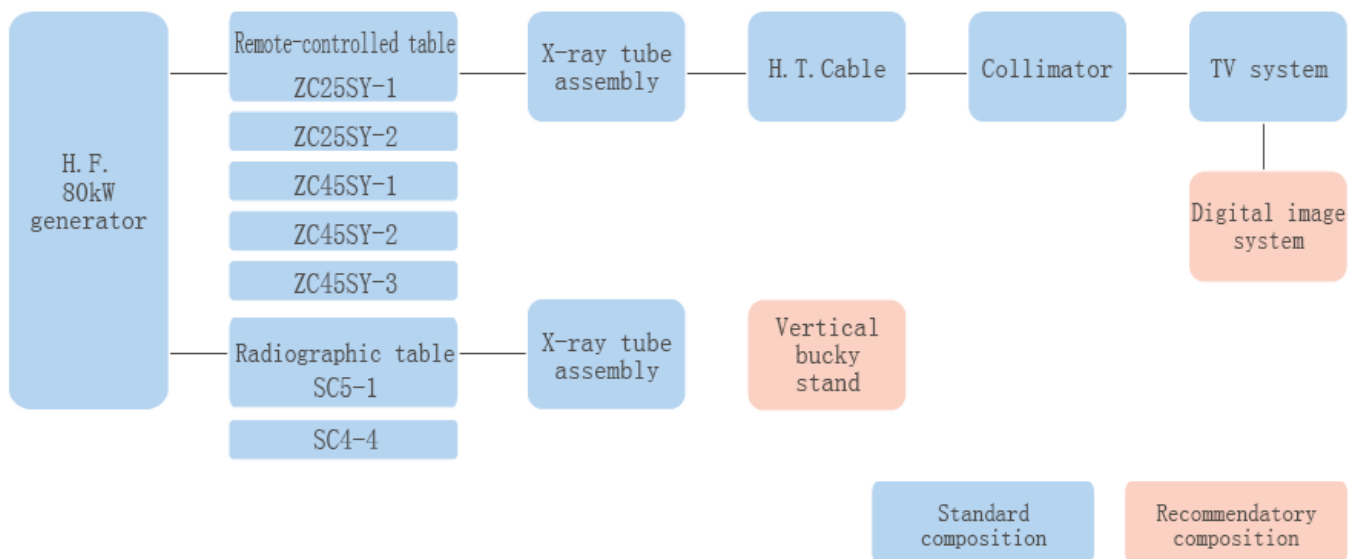

(500mA)-CE*

Microprocessor control More functions more flexibility

Anatomical exposure position selection

- Exposure parameters can be set based on patient body size and exposure positions. The parameters can also be corrected stored.

Safety function

- The error self-diagnosis function can determine problems quickly and accurately. It can execute protection automatically and display error code for maintenance.

APR function

- Programmable functions, provides 90 memory programs for radiography. The parameters can also be set manually.

X-ray tube protection

- X-ray tube heat capacity and load capacity are managed and protected by computer programs, to allow maximum utilization of the tube capacity and exposure parameters.

Excellent image processing

- Digital dynamic noise reduction, image positive/negative reverse, transverse/vertical flip, black spot correction, LIH.
- Diagnostic table, motor driven table tilting and tabletop moving at head end electrically.
- Combined with TV system to do the remote operation, can meet requirements of TV fluoroscopy and spot film.
- All electrical movement of spot film device make “cross” four division radiography.



Transverse movement



Longitudinal movement of spot film device



- Frequency conversion technology is applied to the table tilting, makes movement smooth and reduce system noise. Compressing direction movement of spot film device



Longitudinal movement of table top



Carbon fiber table top, high intensity low absorption



Rotatable foot support (optional)



No.-SC4-4

Integrated Radiographic Table



Remote Table No.-ZC15XY-1

X-ray Generator	Microprocessor controlled 500mA
Remote Table	No.-ZC15XY-1
Integrated Radiographic Table	No. SC4-4
Image Intensifier	9" I . I .
TV Monitor	14" Monitor
X-ray Tube Assembly	

TRUMP 010

The Mobile series C-arm X-ray Unit

Specification

Fluoroscopic Capacity

- Max rated capacity: Tube Current 4mA, Tube Voltage 120kV
- Automatic Fluoroscopy: Tube Voltage:40kV~120kV adjust automatically
- Tube Current:0.3mA~4mA adjust automatically
- Manual Fluoroscopy: Continuous tube Voltage:40kV~120kV; Continuous tube Current:0.3mA~4mA
- Pulse Fluoroscopy: Continuous tube Voltage:40kV~120kV; Continuous tube Current:4.1mA~8Ma

Photography Capacity

- Max rated capacity: 5.0 KW
- Tube voltage, mAs : 40kV~120kV
20~100mA 1~180mAs
- Plateholder size: 200mm×250mm(8"×10")
or 250mm×300mm (10"×12")

X-ray Tube

- X-ray tube special for High frequency:
Fixed anode x-ray tube with 2 focus:
Large focus: 0.6, small focus: 0.3
- Inverter Frequency: 40kHz
- Thermal capacity: 150kJ (200kHU)

Video System

- Image Intensifier: Image Intensifier made by TOSHIBA (9")
- CCD vidicon: Imported CCD Vidicon with ultra-low luminosity
- Monitor: Horizontal 1000 lines and vertical 800 lines,
- Bandwidth: 12.5MHz, Image/sec: 25
- CCU (central control): Recursive filter: K=8, 7 images storage, image upright, image overturn, positive & negative image; LIH (last image freeze) , and OSD (monitor display)



Structure

- Direction-wheel: $\pm 90^\circ$ revolution, can change the moving direction of the unit.
- Ascending & descending
- range of pillar $\geq 400\text{mm}$
- C-Arm: Forward and backward movement: 200mm
- Revolution around horizontal axis: $\pm 180^\circ$
- Revolution around vertical axis: $\pm 15^\circ$ Slip on orbit: $120^\circ (+90^\circ \sim -30^\circ)$

TRUMP 011

The high frequency mobile X-ray unit

Technical Specifications:

- Output: 3.2kW
- kV: 40~ 110kV
- mA: 10~ 60mA
- mAs: 1~ 250mAs
- X-ray tube: 1.5mm focal spot
- Power supply: 220V, single phase
- Arm rotation: $\pm 90^\circ$
- Vertical movement: $\geq 140\text{cm}$

Features:

- Suitable kinds of power supply conditions.
- High frequency generator, higher image quality, shorter exposure time, lower radiation.
- Small rotation radius.
- Stronger power, any position radiography.
- X-ray tube can rotate $\pm 90^\circ$ in one horizontal plane, improve the patient flow rate.
- X-ray tube, smaller focal spot to acquire better image.

Option:

- remote hand switch.



New advanced full body DR system**Introduction**

- The newest DR technology fulfils the dream of full digital of X-ray image. The excellent image quality reaches the highest level. The fast-image ability minus diagnosis time in big scale and improves your work-flow-rate. The requirements of overload clinical work can be reached.

High Quality Images

- High quality image High resolution, high quality images
- provide plenty details and diagnosis information.

Instant Imaging

- The image can be displayed in 5 seconds after the
- exposure, the film-developing is not needed any more.

Large Dynamic Range

- The 14bit acquisition make sure that all information from
- skin to the bones can be gained just in one exposure.
- The clinical range of X-ray radiography is enlarged.

High MTF DQE

- Image details contracts and SNR are much better than
- traditional film; the image quality is much improved.

Wider Exposure Dynamic Range

- The wide exposure dynamic range is the guarantee of
- high quality image, which can be reached in low dose.

Digital Image

- Digital image will not need paper documents any more.
- And the image can be shared by internet very easily.

Easy Operation

- The process of exposure, connecting, transmitting,
- saving and printing can be automatically controlled,
- and you will liberate from the complicated work.

Simple Service

- The simple system is cost-effective. Digital applications
- improve efficiency and reduce film costs as well as the
- time associated with conventional cassette handling.

TRUMP 012

The new advanced digital radiography system

Advanced System Design

Outstanding Image Functions

System

Characters

The fully application of state of art technology

- Combining the state of art technology of a-Si FPD detector with special image processing technology to fulfill high quality digital image.
- Open image workstation makes operation very easy and have strong processing functions.
- System design and unit integration ability guarantee high quality image.

Complete DICOM support

- The newest version DICOM 3.0(2000 version) and the special requirements of DR image is fully supported.
- It's compatible with lower versions so that it protects the original investment of the hospital.

Multi-function design

- Multi-function in one unit, according to the different clinical requirements, Optima URS or table can be chosen, one DR can finish the test of whole body.
- One panel with many body parts, 17"×17" FPD can fulfill the big part such as breast test, the FPD doesn't to be rotated.

System safety design

- The system safety operation is guaranteed to meet the daily operation requirements.
- Special data base design to avoid data lose by improper operation. The data safety is guaranteed.
- At the high frequency of exposure and radiography, the system can work in high efficiency and stable to meet the requirements of high patient passing rate.

Module extendable design

- Based on the standard composition, it can be extended according to the customers' requirements.
- Without HIS, worklist, diagnosis workstation, laser printer and CD-RW are options.
- The fully solution from single workstation to whole PACS system.



Work station	Outstanding image processing functions	Database management	Complete DICOM 3.0 support
Software	·Automatic/Manual ROI window level & window width.	·Patient information (patient name, ID, date, etc.) can be stored and revised.	DICOM print support
Functions	·Automatic/Manual electric cut. Image flip, rotation, mirror image. ·Continual zoom & roam. ·Image measure, notation & enhancement.	·Convenient for enquiry.	DICOM archive support DICOM transmission support DICOM worklist support DICOM 3.0 support (2000 edition)

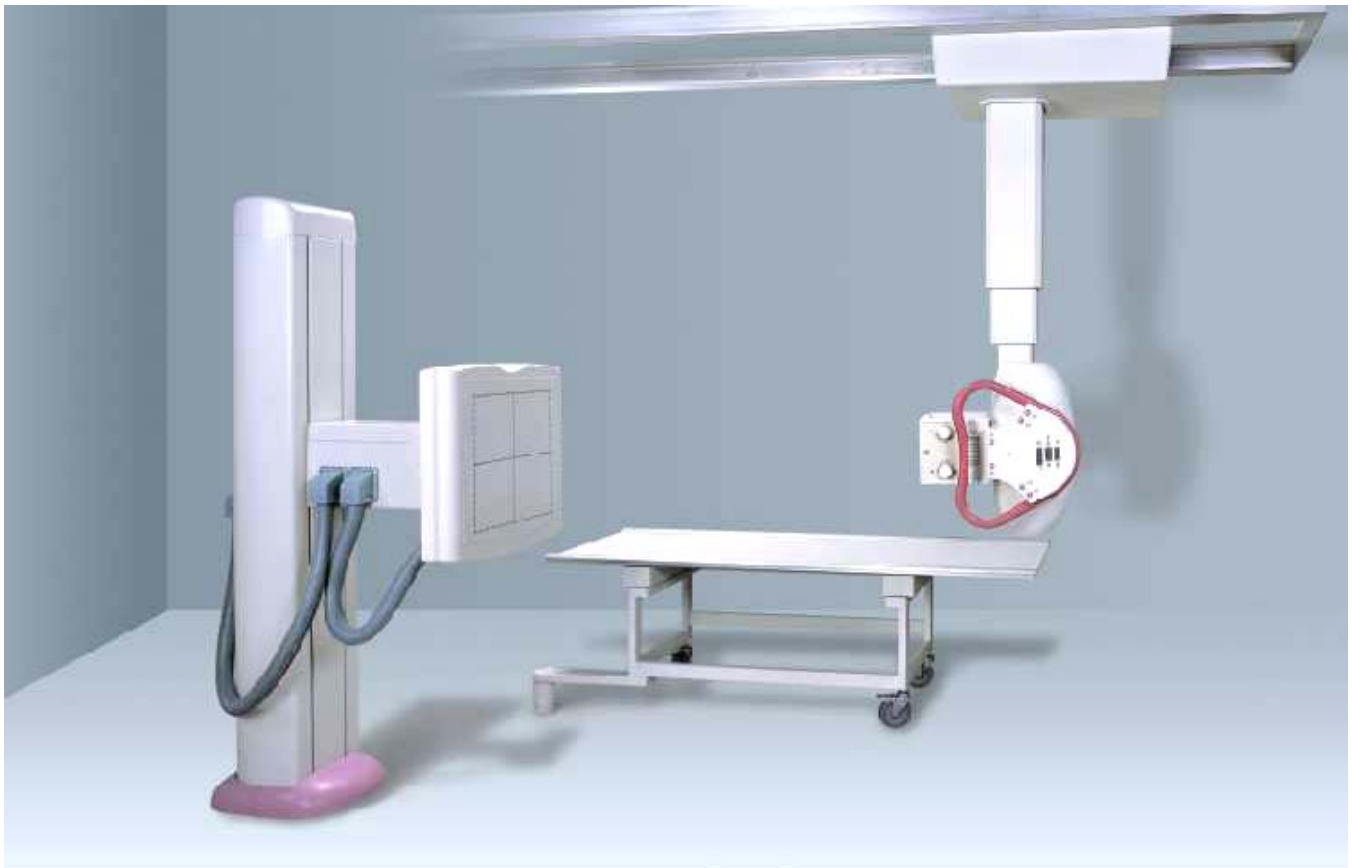

The new advanced digital radiography system

- Latest patent design.
- Single panel, full function.
- Can perform radiography to any body position, and oblique radiography.
- Full-auto tracking and positioning.

Various System Configuration Meet Different Clinical Requirements

- Multi-function Integrated Design
- ·Patent DR system.
- ·Bucky stand / radiography table design to meet the full
- range requirements from chest to general radiography.
- ·X-tube and flat panel full automatic tracking functions to
- improve the efficiency.
- ·The big range movement of Ceiling system with table
- movement to meet the requirements of whole body
- different position radiography.

TRUMP 013

Low-Intensity Portable X-Ray Imaging Scope



Price:

NAME	MODEL	NOTE
Low-Intensity Portable X-Ray Imaging Scope	TRUMP-50A	The model A just can be used for fluoroscopy .The model B can be used for both in fluoroscopy and taking the photo (With film-making function). The size of the photo: 5×7 inch
	TRUMP-50B	
	TRUMP-75A	
	TRUMP-75B	

Note:

- The film of the TRUMP-75 is clearer than the TRUMP-50, but tell the truth, the maintain rate also is higher than the TRUMP-50 MODEL, my suggestion is that you had better choose the TRUMP-50 MODEL, they are used better in sudan market.They have been used for 2 years and there are no machines need to be repaired. The quality is very good. Because the weather in your country is very high,so all the units which are sold in your market need to be adjusted to meet your weather needs.

-
- Pls see the base of the machine, our base is made of the round and hardness figure, which is burliness than the two feet figure.
 - Our product's main parts(vacuum porcelain imaging strengthening machine) is made by our own,so the price and the quality is the best.Most of the Chinese handheld X-RAY machine's imaging strengthening machines are bought from my manufactory.

Brief Introduction

- Low-Intensity Portable X-Ray Imaging Scope (the following in short X-Ray Imaging Scope), a new type of X-Ray medical instruments in the world, consists of main engine and power supply. From the appearance, the main engine adopts the structure of C-Type-Arm, which amplifies the radius of observation. At the same time, the materials select ABS engineering plastics, heightening the insulation capacity.
- Because of adopting MCP-X-Ray imagine strengthening device, having compact texture, high gain, high resolution, the scope can produce clear real-time images without darkroom. The advance technology of widening pulse is used to control electrical appliance of X-Ray tube, which has many measures to be protected, so it has high working stability and no noises.
- In addition, the scope takes strict precautions, the leak of X-Ray reducing, and then the operators do not need any protections. This scope applies to orthopedics and pediatrics in the hospitals and to diagnose IUD for childbearing-age women in time. Especially, it applies to various field rescues in such as industry materials and apparatus quality inspection, athletes, armies, field working and safety checking, and so on.
- The scope belongs to I Class B Model Equipment.



Specifications and Conditions

1 Specifications:

- Output image size: $\Phi 50\text{mm}/\Phi 75\text{mm}$
- Survey thickness: $\leq 300\text{mm}$
- X-Ray tube voltage: 35~70kv continual adjust
- Voltage accuracy: $\leq \pm 1\%$
- Tube current: 0.25~0.5mA continual adjust

- Current accuracy: $\leq \pm 2\%$
- Resolution: $\geq 40\text{lp/cm}$
- Ratio : $\geq 4\%$
- Gray level: ≥ 10 level
- Main engine working frequency: 20KHz
- Radiation leakage: the corresponding National Standard GB9706.12

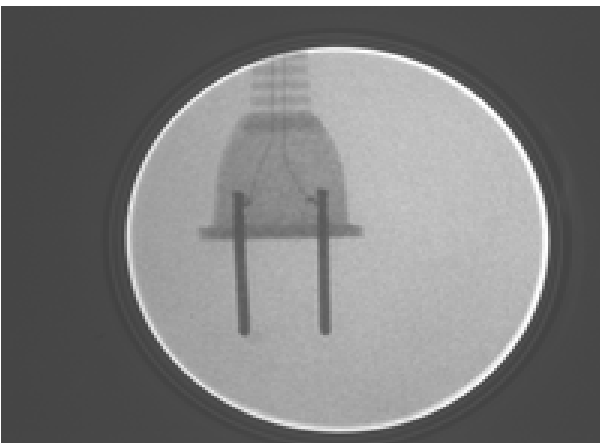
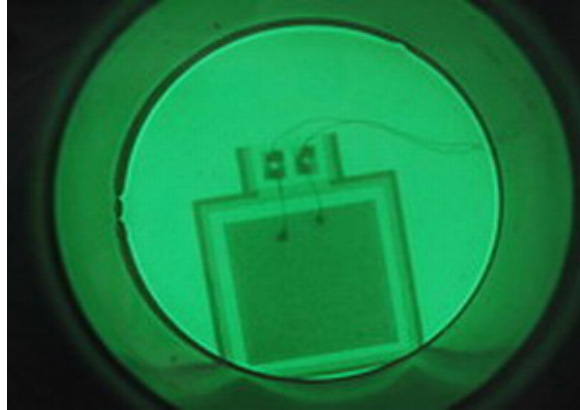

2 Conditions

- Temperature: 50C~40oC
- Opposite humidity: $\leq 80\%$

3 Power supply

- 220V $\pm 10\%$ 50Hz~60Hz
- Power consumption: 80W
- Resistance maximum: 0.5
- Releasing current machine: 1 A

4 Shape size and weight

- Length \times width \times thickness: 550 \times 420 \times 130
- Main engine: 3.6Kg Guard: 0.61 Kg

-
-
- Gross weight: 9Kg

Working principle

- X-Ray Imaging Scope is made up of different parts in the picture I . When put through power supply, turn on “start” button, and then the scope begins to work. The pulse signal from main engine I amplified through efficiency reaches to X-Ray tube anode, while the pulse signal from main engine II amplified reaches to X-Ray tube wick, which releases X-Ray. Then the corresponding number KV/ μ A will come out on the board. This moment the object is laid between X-Ray source and image strengthening machine, on whose monitor we will see the clear image. In order to work stability, the system adopting the technology of widening pulse, makes tube current and tube voltage stable, and the X-Ray tube works in good condition. Due to the function of high voltage starting slowly, the X-Ray tube anode doesn't have the phenomenon of high voltage being too high. The main control machine with the mini-slice equipment working at the frequency of the 20KHz, improves the entire system's efficiency and clears away the noises, and it supplies workers for quite environment with a smaller volume. The power supply of perspective device adopts a switch with high frequency and high efficiency, having overall protections. To ensure the safety of perspective device, the scope takes different measures, so the device is safe and reliable.

Service Manual of X-ray Detector

1. Detection Methods of General Failures of X-ray Detector:

X-ray detector is a kind of precision instruments and shall be repaired by professional technicians. When repairing, firstly remove visible failures such as broken wire, touched wire, key switch and fuse and do not disassemble the instrument and its power switch.

- If the digital display shows voltage and current of X-ray tube, these is x-ray; if the display is black, there is usually a failure in image intensifier and it should be replaced.
- If the digital display works but there are not voltage and current of X-ray tube, the power supply should be normal and there may be a failure in mainboard or voltage doubler and please have it repaired.
- After the instrument is electrified, if the panel shall display but cannot work normally and work indicator light does not work, you should check: a. if driver inserter is fixed; b. if panel inserter is fixed; c. driving tube is fixed.
- After the instrument is electrified, if the over-temperature indicator light is on, you should check: a. if the temperature of high-voltage X-ray source is too hot. If it is not too hot, please check if the inserter on base of high-voltage X-ray source is fixed.
- After the instrument is electrified, if the instrument does not work, you should check: a. 24V power supply; b. if panel displays. If it does not, send it to manufacturer for repair; c. check DC/DC. If it is not normal, send it to manufacturer for repair.
- If intensifier or voltage doubler is broken, send it to manufacturer for repair.

2. Adjustment Method and Process of Image

- Before turning on the instrument, minimize voltage and current. After turning on the instrument, adjust voltage and current according to the sizes and thickness of perspective object until the image is clear. The parameters for reference are as follows:
- For limbs of adult: adjust current of display panel to 0.5mA and voltage to 65-90KV;
- For limbs of child: adjust current of display panel to 0.3-0.5mA and voltage to 45-65KV;
- For other objects: adjust them according to conditions.

3. Layout of Inner Components of X-ray Instrument

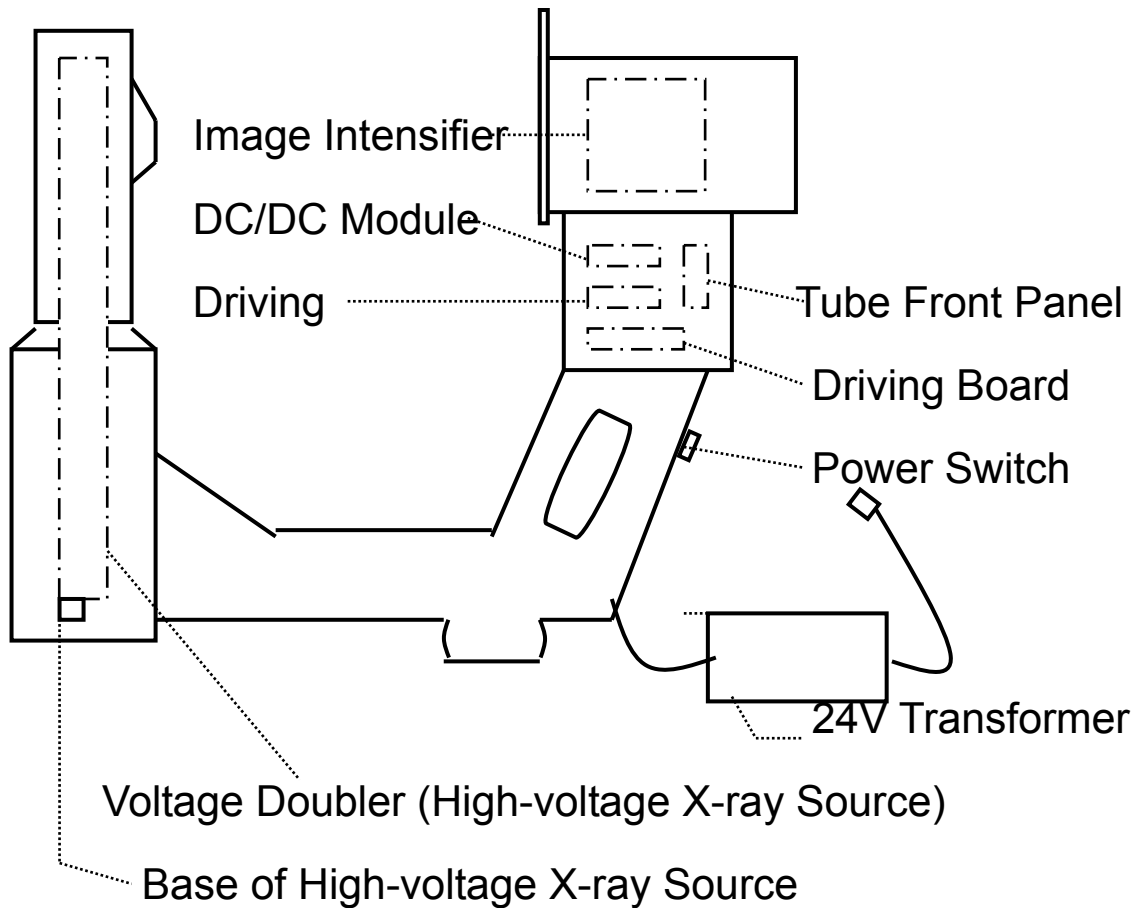

Note: the above broken lines are the layout of main inner components of X-ray instrument.

TRUMP1 For people use**Advantages:**

- Integrated with high frequency and high voltage generator, main control system, intelligent computer system, numeric display and beam limited device, it is designed and manufactured precisely and compactly, more flexibly and widely used.
- Using the technique of inverse converter for HF and computer-controlled closed-loop adjusting System, stable high voltage output is generated and high-quality images can be obtained.
- Using the buttons of KV and mAs to adjust the photographic parameters, display them on high-brightness LEDs, interlock protection conditions is determined by software, which is convenient for doctors to operate.
- X-ray Tube is placed in lead cylinder which can effectively shield the gamma leakage and protect environment and operators' safety.
- 20 radiographic conditions are preset and can be customized according to user requirements.
- Photography Time is controlled precisely by computer, host will automatically delay 10 seconds at the end of photography which can effectively control photography interval, avoid overloading and achieve automatic protection.
- Hand-controlled and remote-controlled photography function
- Using computer to monitor fault sources, the computer will cut all outputs, display fault code and identify the fault reasons if a fault appears.
- Suitable for all kinds of cassettes.

**Structural performance**

- Radiography can be launched after X-ray apparatus is suspended on the frame.
- The fuselage of X-ray apparatus is suspended on the frame, can rotate left and right at larger than or equal to $\pm 90^\circ$, X-ray tube head can rotate at 90° which is easy to project in different angles.

-
-
- The arm can move up and down, has Servo-balance and lock-up device.
 - The fuselage of X-ray apparatus weighs 19Kg, is more convenient to carry. The frame weighs 23 Kg, is more flexible to move at different places.
 - The frame can be disassembled and folded quickly, then putted into trunk, which can make out-call more convenient.

Technical Specification (there are three models)

Model 1:

- Max. photograph tube voltage: 90kV/22mA
- Max. photograph tube current: 50mA
- Max. Output: 2.0kW
- Exposal time: 0.02s ~ 4.0s
- MAS scope: 0.5mAs ~ 160mAs with 46 alternations
- Voltage scope: 40~90kV KV with 26 alternations
- Main frequency: 30kHz
- Max. light field: $\leq 35\text{CM} \times 35\text{CM}$ @65CM SID
- Min. light field: $\leq 5\text{CM} \times 5\text{CM}$ @100CM SID
- Focus size: 2.3mm
- Power: 220V \pm 10% single phase alternating current with the frequency of 50Hz \pm 1Hz
- Resistance: $\leq 1.0 \Omega$
- Power capability: $\geq 2.5\text{kVA}$
- Electricity protection type: Class I, Type B
- Weight: 19kg

Model 2:

- Max. photograph tube voltage: 100kV/20mA
- Max. photograph tube current: 60mA
- Max. Output: 2.4kW
- Exposal time: 0.008s ~ 3.33s
- MAS scope: 0.5mAs ~ 160mAs with 46 alternations
- Voltage scope: 40~100kV KV with 31 alternations
- Main frequency: 30kHz
- Max. light field: $\leq 35\text{CM} \times 35\text{CM}$ @65CM SID
- Min. light field: $\leq 5\text{CM} \times 5\text{CM}$ @100CM SID
- Focus size: 1.5mm
- Power: 220V \pm 10% single phase alternating current with the frequency of 50Hz \pm 1Hz
- Resistance: $\leq 1.0 \Omega$
- Power capability: $\geq 3.5\text{kVA}$
- Electricity protection type: Class I, Type B

- Weight: 19kg

Model 3:

- Max. photograph tube voltage: 100kV/30mA
- Max. photograph tube current: 70mA
- Max. Output: 3.2kW
- Exposal time: 0.008s ~ 3.33s
- MAS scope: 0.5mAs ~ 200mAs with 48 alternations
- Voltage scope: 40~100kV KV with 31 alternations
- Main frequency: 30kHz
- Max. light field: ≤35CMX35CM @65CM SID
- Min. light field: ≤5CMX5CM @100CM SID
- Focus size: 1.5mm
- Power: 220V ± 10% single phase alternating current with the frequency of 50Hz ± 1Hz
- Resistance: ≤ 1.0 Ω
- Power capability: ≥ 4.5kVA
- Electricity protection type: Class I, Type B
- Weight: 19kg

The Container for X-ray machine, can be option as you like

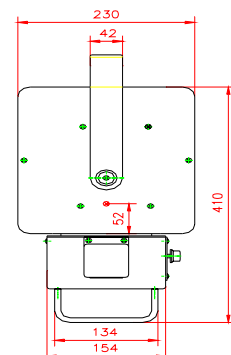
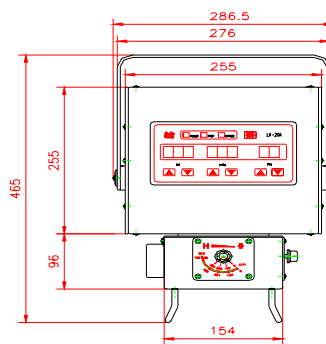

Wall bucky for chest x-rays

Our bucky tray can move as your like.

Introduction:

The standing photographing shelf is suitable for x-ray photographing of abdomen and above .it is made up of high quality rolled steel and the exterior surface is decorated with static spray



plastic ,which is elegant and **durable** .the photographing shelf is supported by a slanted-pole ,which can ensure there is no shake while taking photograph and therefore make the film more clear.

Specification:

Fram:1140*750*310mm,23KG

Main unit:490*400*400mm,19KG

Solution of the problem of imaging fat people

The usage of Anti-scatter grid can settle your problem successfully.

- The grids have superior performance and offer less absorption, which can greatly reduce the scattered radiator producing clearer and diagnostically superior. It is widely used in the Chest X-rays.
- It is produced by Korea producer.



Specification:

- Size: 15*18mm
- focus ranges:1.8M

Lead Strip Positioning

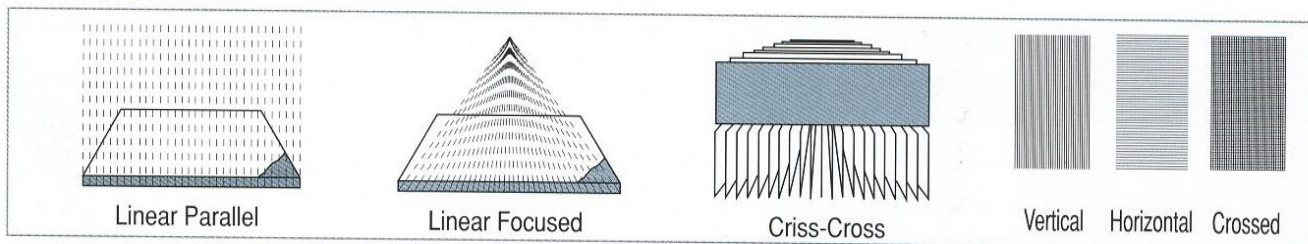

Incorrect Application of Focused Grid.

Correct Application of Focused Grid.

Space Between Strips

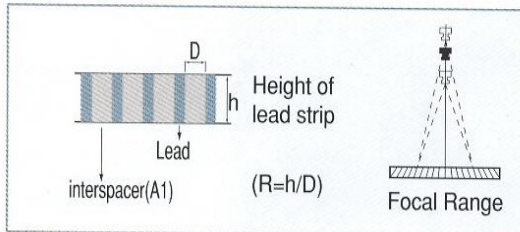
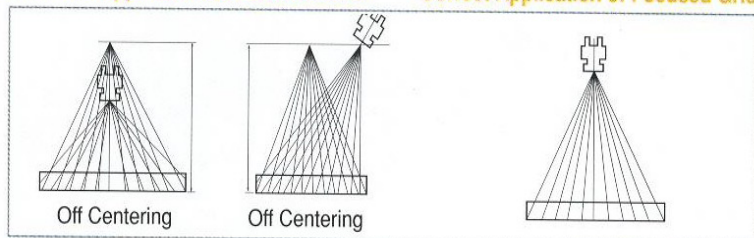

Another advantages of our X-ray machine:

1 The ordinary table or bed is OK for supine films, no special x-ray table needed.

TRUMP2 For animal special use

Advantages:

- Integrated with high frequency and high voltage generator, main control system, intelligent computer system, numeric display and beam limited device, it is designed and manufactured precisely and compactly, more flexibly and widely used.
- Using the technique of inverse converter for HF and computer-controlled closed-loop adjusting System, stable high voltage output is generated and high-quality images can be obtained.
- Using the buttons of KV and mAs to adjust the photographic parameters, display them on high-brightness LEDs, interlock protection conditions is determined by software, which is convenient for doctors to operate.
- X-ray Tube is placed in lead cylinder which can effectively shield the gamma leakage and protect environment and operators' safety.
- 20 radiographic conditions are preset and can be customized according to user requirements.
- Photography Time is controlled precisely by computer, host will automatically delay 10 seconds at the end of photography which can effectively control photography interval, avoid overloading and achieve automatic protection.
- Hand-controlled and remote-controlled photography function
- Using computer to monitor fault sources, the computer will cut all outputs, display fault code and identify the fault reasons if a fault appears.
- Suitable for all kinds of cassettes.

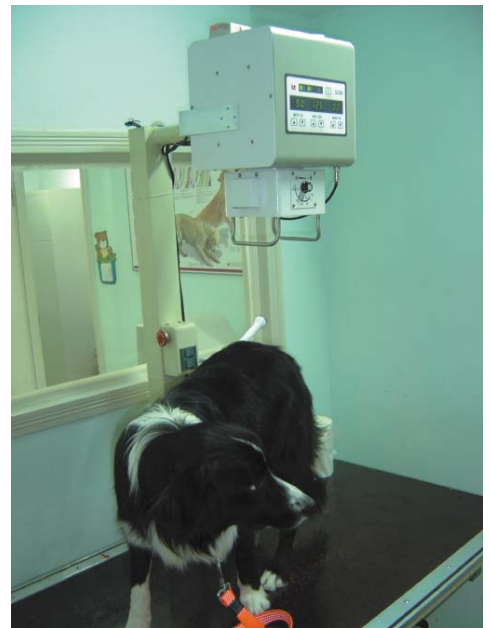

Structural performance:

- Radiography can be launched after X-ray apparatus is suspended on the frame.
- The fuselage of X-ray apparatus is suspended on the frame, can rotate left and right at larger than or equal to $\pm 90^\circ$, X-ray tube head can rotate at 90° which is easy to project in different angles.
- The arm can move up and down, has Servo-balance and lock-up device.
- The fuselage of X-ray apparatus weighs 19Kg, is more convenient to carry. The frame weighs 23 Kg, Can be quickly moved to injured animals and launch diagnosis and treatment.



- The frame can be disassembled and folded quickly, then putted into trunk, which can make out-call more convenient.
- Providing great convenience for animal diagnosis and treatment. Cooperating with beds, it is more suitable for animal hospitals.

Main specifications and parameters:

- Max. photograph tube voltage: 90kV/22mA
- Max. photograph tube current: 50mA
- Max. Output: 2.0kW
- Exposal time: 0.02s ~ 4.0s
- MAS scope: 0.5mAs ~ 160mAs with 46 alternations
- Voltage scope: 40~90kV KV with 26 alternations
- Main frequency: 30kHz
- Max. light field: ≤35CMX35CM @65CM SID
- Min. light field: ≤5CMX5CM @100CM SID
- Focus size: 2.3mm
- Power: 220V ± 10% single phase alternating current with the frequency of 50Hz ± 1Hz
- Resistance: ≤ 1.0 Ω
- Power capability: ≥ 2.5kVA
- Electricity protection type: Class I, Type B
- Weight: 19kg



Use:

- animal hospital, equestrian club, animal quarantine, animal and veterinary, animal laboratory

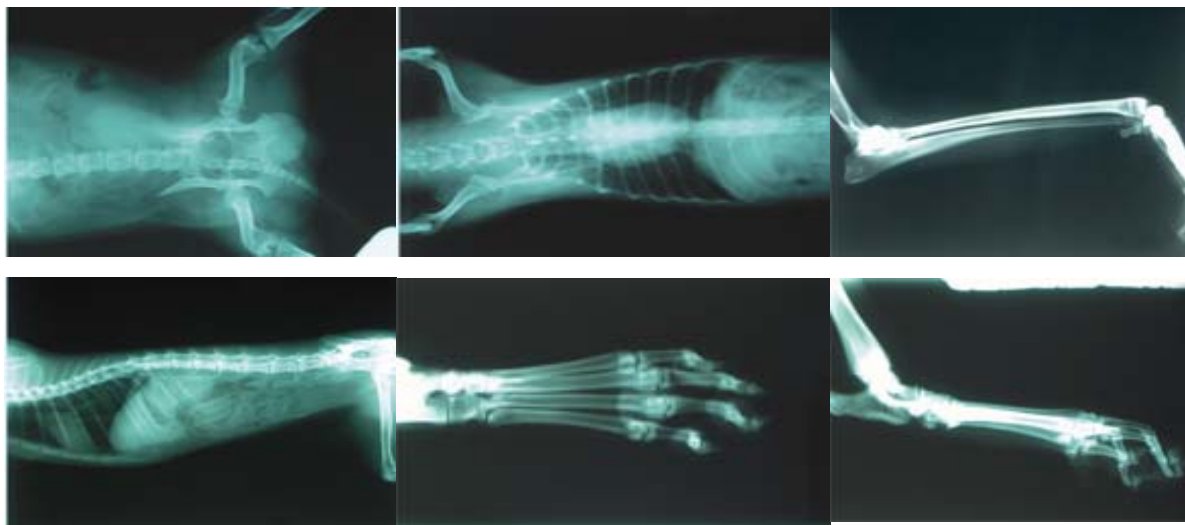

Automatic film processor-CE

Product detail:

- This desk-top small film processor with less expensive price is newly launched in market by CHINA Imaging. It possesses only 0.36 m² ground area with front and rear two output modes for selection. Excellent performance plus affordable price, the machine can be widely applied in middle and small hospital for mode of several machines in one hospital, several machines in one operation room and processing mode instead of traditional manual operation. Its sale price is much lower than similar product and its fix and develop chemical volume is only 4.5L. It is specially designed as a hi-efficiency, energy-saving medical film processing device for user who has some volume of film processing everyday. Max processing width is 14 inch and fastest whole process needs only 90 sec.



Film Processor Features

Small Body

- Ground occupied area is only 0.36 m², which is probably suitable for any small dark room. You don't need to worry about space issue.

High Auto Control

- This product is an auto film processing device controlled by a micro computer. To easily set processing data, adjusting of temperature and speed is set by two groups of potentiometer on control board. Functions like chemical replenish, ready for film processing, solution low-level indicator and every type of alarm, can be automatically realized through LED indicators of control panel. It is easy to understand and operate. Indicators on control panel would let you know all working status at any time. When chemical temperature reaches set value, what you do is only to put a film in and machine will automatically enter working status and make the processing.

Save Chemicals

- Develop and fix volume of this product is only 5 liters which may largely reduce new chemicals replacement cycle and keep chemical effectiveness at a good status. To reduce air oxidation to chemicals, a special designed anti-oxidation cover is placed in chemical tank. It largely reduces air oxidation to chemical solution and meanwhile it reduces oxidized chemical's pollution to air in working room.

Hi-efficient Dryer

- There is a hot-air duct-mode dryer system of hi-efficiency and squeeze roller of hi-performance in this product dryer section. This guarantees the high performance of dryer required by mass processing of film

in a high-temperature environment.

High Working Reliability

- This machine has state of the art and matured design in film-transport rack's structure, roller transport, electronic control, hot-air dryer, chemical replenish and circulation. It has a long life period for usage. Film jam, scratches and film not dried will not occur.

Film Output Selectable

- Two modes are designed for this product's film output way, they are:
 - ✚ Front film output mode: in this mode the entire machine is placed in dark room for processing operation. Film will be out on the top of machine after processing.
 - ✚ Rear film output mode: what you do is only to adjust a group of guide in dryer exit to the status of rear-film-output, and make an 8×48cm hole in the dark room and separation wall, mount the film collector below the hole. Film output is collected in light room.

Fast Processing Speed

- This product is designed according to hi-speed requirement on film processing. Fastest whole processing time of machine can be at 90 sec, suitable for any urgent diagnosis or hospital that may require fast processing.

Cost Effective

- This product market sale price is lower. It applies for organization that processes 30~150 pieces everyday. Chemical, power and water consumption of this machine is low. Usage cost of whole machine is 25%~40% lower than similar processor, so it applies for the one with less film processing volume, one hospital with several machines, and the hospital or department that one working room is configured with several machines.

Easy Maintenance

- Easy maintenance is well considered during this product's design. Besides features of small machine body, light weight, easy to move, the machine's racks from develop to dryer can be all easily released out and washed by water for maintenance. Electrical control part is enclosed and mounted below entrance feeding box. By opening external cover of this E-box, you may do the maintenance easily on every electronic component inside.

Energy Saving

- Max power consumption of this product whole machine is only 2.2 KW, water consumption per minute is only 2 liters which will be automatically opened when processing film. If no film processing, water flow and dryer heating system, etc, will automatically enter standby and energy saving mode.



TRUMP 015 **Dental x-ray unit**

TRUMP1- Micro focus Dental x-ray unit

Type 1 mobile type

Product detail:

- The product is designed successfully by our company recently with international advanced level, which is a new type of dental x-ray unit. It must be used in coordination with dental film with intensifying screen. The product is suitable for filming oral cavity x-ray in every hospital, oral cavity outpatient service, private clinic and clinical or teaching usage of relative medical college and research institution.



I. Features of the unit:

- Filming in coordination with dental film with intensifying screen by making use of 1.5mA X-ray output capacity. Compared with 7mA-10mA dental unit in the world, X-ray radiation dosage has reduced by 92%-98% to protect health of patients.
- The scattering or leaking x-ray dosage in the air where one meter away from radius of shining center is lower than 4% of defined limited value to protect health of doctors.

-
-
- The clearest image can be acquired by making use of microfocus x-ray tube.
 - Using microcomputer controller, which is very convenient and accurate. Only according to relative standard picture, the best exposure control can be reached.
 - It has infrared remote control and linear control and the direction and anti-interference of infrared remote control are strong.
 - It has flexible and firm suspending arm to adjust ball tube freely to any angle or direction and balance in any position.
 - It is equipped with firm and steady seat and back, and connected with machine to make patients feel comfortable and safe. The height of seat can be adjusted according to different height of patients.

Technical parameter

- Power requirement: 50Hz, 220V±10%
- Peak point voltage: 65 kvp
- Peak point current: 1.5mA/3mA/7mA/10mA
- Maximum power: ≤ 300w
- Exposure time: 0.1-0.2s
- Radiation diameter: 6cm
- Focus spot: 0.6 mm×0.8 mm
- X-ray tube longitudinal displacement: ≥ 600mm
- Vertical travel of rocker: ≥ 400mm
- Vertical travel of seat: ≥ 200mm

Type 2 Wall mounted type

Product detail:

- The product is designed successfully by our company recently with international advanced level, which is a new type of dental x-ray unit. It must be used in coordination with dental film with intensifying screen. The product is suitable for filming oral cavity x-ray in every hospital, oral cavity outpatient service, private clinic and clinical or teaching usage of relative medical college and research institution.



Features of the unit:

- Filming in coordination with dental film with intensifying screen by making use of 1.5mA X-ray output capacity. Compared with 7mA-10mA dental unit in the world, X-ray radiation dosage has reduced by 92%-98% to protect health of patients.
- The scattering or leaking x-ray dosage in the air where one meter away from radius of shining center is lower than 4% of defined limited value to protect health of doctors.
- The clearest image can be acquired by making use of microfocus x-ray tube.
- Using microcomputer controller, which is very convenient and accurate. Only according to relative

standard picture, the best exposure control can be reached.

- It has infrared remote control and linear control and the direction and anti-interference of infrared remote control are strong.
- It has flexible and firm suspending arm to adjust ball tube freely to any angle or direction and balance in any position.

Technical parameter

- Power requirement: 50Hz, 220V±10%
- Peak point voltage: 65 kvp
- Peak point current: 1.5mA/3mA/7mA/10mA
- Maximum power: ≤ 300w
- Exposure time: 0.1-0.2s
- Radiation diameter: 6cm
- Focus spot: 0.6 mm×0.8 mm
- X-ray tube longitudinal displacement: ≥ 1600mm
- Vertical travel of rocker: ≥ 600mm

Type 3 fixed type

Product detail

- The product is designed successfully by our company recently with international advanced level, which is a new type of dental x-ray unit. It must be used in coordination with dental film with intensifying screen. The product is suitable for filming oral cavity x-ray in every hospital, oral cavity outpatient service, private clinic and clinical or teaching usage of relative medical college and research institution.

Features of the unit:

- Filming in coordination with dental film with intensifying screen by making use of 1.5mA X-ray output capacity. Compared with 7mA-10mA dental unit in the world, X-ray radiation dosage has reduced by 92%-98% to protect health of patients.
- The scattering or leaking x-ray dosage in the air where one meter away from radius of shining center is lower than 4% of defined limited value to protect health of doctors.
- The clearest image can be acquired by making use of microfocus x-ray tube.
- Using microcomputer controller, which is very convenient and accurate. Only according to relative standard picture, the best exposure control can be reached.
- It has infrared remote control and linear control and the direction and anti-interference of infrared remote control are strong.



- It has flexible and firm suspending arm to adjust ball tube freely to any angle or direction and balance in any position.
- It is equipped with firm and steady seat and back, and connected with machine to make patients feel comfortable and safe. The height of seat can be adjusted according to different height of patients.

Technical parameter

- Power requirement: 50Hz, 220V±10%
- Peak point voltage: 70 kvp
- Peak point current: 3mA/7mA/10/mA
- Maximum power: ≥ 400w
- Exposure time: 0.1-0.2s
- Radiation diameter: 6cm
- Focus spot: 0.6 mm×0.8 mm
- X-ray tube longitudinal displacement:≥ 800mm
- Vertical travel of rocker: ≥ 400mm
- Vertical travel of seat: ≥ 200mm
- Rotatory range of tube: 0-360°C

TRUMP2-HIGH FREQUENCY DENTAL X-RAY UNIT

Type 1 fixed type

Product detail

The product is designed successfully by our company with international advanced level, which is a new type of dental x-ray unit with few scatter & leakage X-ray to image high definition film. This machine is suitable for all levels hospital, oral cavity clinic, individual clinic and relevant medical universities and colleges, the R&D institution.

Features of the unit:

The unit uses high frequency DC, lower grenz ray output. The advanced unit is more flexible to operate.

Take a photograph adopting 3mA x-ray output and matching with our dental film (packing with intensifying screen), reduce the radiation dosage than the domestic and international machine, and protect the patient's and doctor's health.

The scatter & leakage x-ray is accord with GBZ130—2002 standard “Medical X-ray health diagnosis protection standard” , to protect doctor's health.

Micro size spot to ensure high image resolution. With the filament pre-heat, prolong the usage of X-ray tube.

It is convenient and accurate to adopt microcomputer controller, can achieve the best exposure condition, only



press the corresponding standard figure.

With good direction and jam resistance, the unit can be controlled by infrared remote control and wire control. It has two flexible and firm suspending arm to adjust ball tube freely to any angle or direction and balance in any position. It also increases the length of arm.

It is equipped with firm and steady stand back and connected with machine to make patients feel comfortable and safe. The chair can be adjusted according to different height of patients.

Technical parameter

- ✚ Power requirement: 50Hz, 220V±10%
- ✚ Peak point voltage: 70 kvp
- ✚ Peak point current: 3mA/7mA/10/mA (DC)
- ✚ X-ray frequency: 30 kHz
- ✚ Maximum power: ≥ 400w
- ✚ Exposure time: 0.1-0.2s
- ✚ Radiation diameter: 6cm
- ✚ Focus spot: 0.6 mm×0.8 mm
- ✚ Horizon range of tube: ≥ 2000mm
- ✚ Vertical travel of tube: ≥ 1500mm

Type 2 wall mounted type

Product detail

- The product is designed successfully by our company with international advanced level, which is a new type of dental x-ray unit with few scatter & leakage X-ray to image high definition film. This machine is suitable for all levels hospital, oral cavity clinic, individual clinic and relevant medical universities and colleges, the R&D institution.

Features of the unit:

- The unit uses high frequency DC, lower grenz ray output. The advanced unit is more flexible to operate.
- Take a photograph adopting 3mA x-ray output and matching with our dental film (packing with intensifying screen), reduce the radiation dosage than the domestic and international machine, and protect the patient's and doctor's health.
- The scatter & leakage x-ray is accord with GBZ130—2002 standard “Medical X-ray health diagnosis protection standard” , to protect doctor's health.
- Micro size spot to ensure high image resolution. With the filament pre-heat, prolong the usage of X-ray tube.
- It is convenient and accurate to adopt microcomputer controller, can achieve the best exposure condition, only press the corresponding standard figure.



- With good direction and jam resistance, the unit can be controlled by infrared remote control and wire control.
- It has two flexible and firm suspending arm to adjust ball tube freely to any angle or direction and balance in any position. It also increases the length of arm.

Technical parameter

- Power requirement: 50Hz, 220V±10%
- Peak point voltage: 70 kvp
- Peak point current: 3mA/7mA/10/mA (DC)
- X-ray frequency: 30 kHz
- Maximum power: ≥ 400w
- Exposure time: 0.1-0.2s
- Radiation diameter: 6cm
- Focus spot: 0.6 mm×0.8 mm
- Horizon range of tube: ≥ 2000mm
- Vertical travel of tube: ≥ 1500mm

TABLE-TOP DARKROOM

Unique design

- Develop in lightroom: extricate you from darkroom
- Simple and convenient: save time and gain benefit
- Small volume: operate on the table, save space
- Tooth image: it is clearer than any method of developing



TRUMP 016

ORAL PANORAMIC X-RAY UNIT

Product characteristic

- Revolutionary SCSRS imaging plates, the most abundant procedure can provide more clinical diagnosis message and jaw image information.
- The advanced scanning makes image reducing and definition reach a high level.
- Scan localization is more accurate, less image interference, to get more precise, truer clinical diagnosis message.
- Operating environment is more scientific, rational, intuitive, simple and convenient.
- The appearance and structural design are succinct and smooth, it is a



perfect combination of the technology and design.

Technical parameter

- input voltage
 - ⚡ 220V±10%
 - ⚡ 50HZ±1HZ
 - ⚡ fuse≤1Ω
- input power
 - ⚡ Instantaneous loading:2500W
 - ⚡ Standby mode:110W 0.5A
- fuse 15A (φ6×30)
- anode voltage auto 60KV~88KV ≤10% auto set
- manual 60kv~88kv ≤10%
- anode current panoramic 12mA ±20%
- jaw 12mA ±20%
- focus spot size 0.5mm×0.5mm
- zoom in 1.20-1.30
- total filtering 2.5mm Al
- exposure time panoramic 14s
- film size 150×300mm
- x-ray cassette meisheng 150mm×300mm
- x-ray intensifying screen MEISHENG MSL-40
- lift range of tube head 853 mm ~1643mm
- 853 mm ~1643mm
- lifting device manual electromagnetism locked
- net weight 160kg

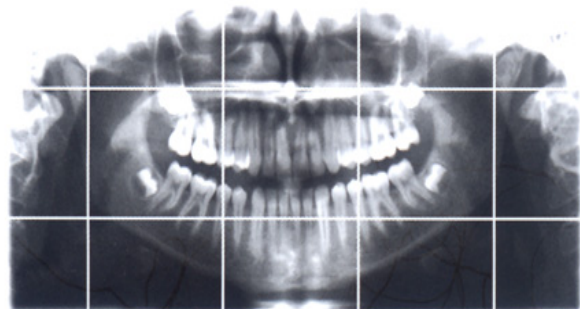

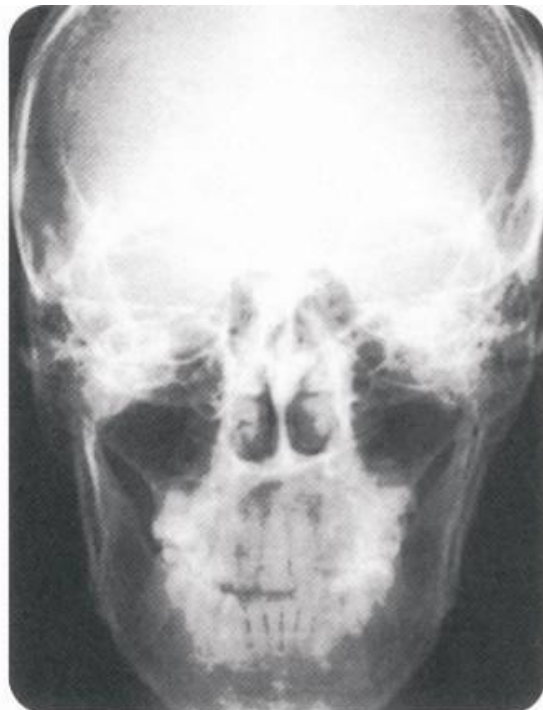

TRUMP 017

Mammography machine

Brief introduction

- The mammography System is mainly used to acquire X-ray images of human breasts for clinical diagnosis. It is a film-based mammography system and proves to be an effective solution for breast diseases.
- The mammography system consists of the main body unit and the control console (see the picture of the system), including the key components of dual-focus X-ray tube, collimator, rotating anode starter and protection system, high-frequency and high voltage generator (frequency: 40KHz), tube filament heating system, breast compression device, supporting arm and other mechanical and electric devices.
- X-ray tube is one of the major components which decide the breast image quality. MCR-6000 system uses a high power rotating anode of dual-focus tube with Mo target and Be window (bias dual-focus: 0.1mm/0.3mm) to ensure the clear images. The carbon-based bucky features high transmission rate, and high efficiency in blocking the scattered X-ray, which is also helpful for improving image quality. The automatic exposure control system is highly sensitive and quickly reactive, so the exposure is automatically adjusted according to the factures of age and thickness etc.



High standard and high resolution image

-
-
- Spatial resolution: 20Lp/mm
 - Density resolution: 1.19mm
 - Min. Calcification resolution: 130um.

Features of the unit

- The breast compression device is automatically controlled with three speeds. The ascending speed is high to reduce operation time. The descending speed is 1/2 of the ascending speed to prepare for pressing the breast. After getting in touch with the breast, it will automatically decrease its speed and impose pressure. This way the patient feels more comfortable. When the pressure reaches the preset level, it will automatically stop and the actual breast thickness and pressure will be displayed. If the pressing conditions are not proper, the operator may change it on the way until desired conditions are available.

Specification

- Power 220VAC,30A
- High voltage generator
- High frequency constant voltage:50kHz
- Voltage range:20---45KVp, 1KV step
- Max.Current:100mA
- Max. Output power:5kW
- Exposure condition control: Manual/Auto

X-ray tube

- Dual focus:0.1mm/0.3mm
- Anode heat capacity:150KHU
- Anode type: Rotating Anode
- Anode material: Mo

C--arm

- Rotating angle: +180/-160
- SID:65cm Fixed
- Anti-scatter grid: Carbon based fine plate
- Cassette size:18×24cm OR 24×30
- Dimensions Gantry:1810mm×880mm×880mm
Console:960mm×480mm×500mm
- C-arm vertical movement range:600mm
- Overall weight:200Kg

Compressor

- Operating mode: Auto(motor)
- Compression force/method:Max.18Kg/Auto
Intelligent, flexible

fast pressure release

- Compression force display: LED
- Compressor paddle movement range:280mm

Note:

This equipment should be equipped with film processor to make the printing.

The film processor which you purchased from us is also suitable for this equipment.

Set of accessories for X-RAY room use

X-RAY film illuminator

Brief introduction

- CE certified
- The most advanced film clamping device assure easy film insertion, reliable film clamping and easy film take-off.
- Frame is made of highly strong aluminum alloy material which is highly rigid and not deformable.
- Screen is made of imported organic glass panel which has no color fading for long-time use.
- Electronic ballast has advantages of power saving, no flickering and easy switch-on under low voltage.
- Frame and container body is connected by hinge, which assure easy replacement and maintenance of fluorescent tube.
- It is patent product of computer light-regulated illuminator, which has novel cosmetics and stable property.
- Customization service is offered.

Model 1

Super-thin LCD

Standard type



Light-regulated

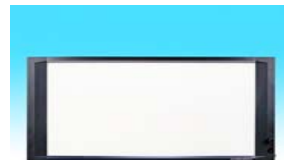

Model 2

Super-thin type

super-thin type



Model 3

super-thin type computer light-regulated



Luxury type

Luxury type



Luxury type common light-regulated



Luxury type computer light-regulated



Equipped with work table



equipped with mobile supporting trestle



Model 4

Wall built-in type

Wall built-in type Computer light-regulated



ordinary type



X-RAY RADIOGRAPHIC CASSETTE

Brief introduction

- CE certified , Manufacture according to international standard.
- The XH series of x-ray radiographic cassette include three types; XH -P is the standard type; XH-PW has ID window; and XH-PM is a patent product with label installation, the three all have different specification in either metric or imperial system.
- The series are made of specified aluminium alloy frame, specified engineering plastics and high-stamina aluminium plate, they look good in shape and are convenient and durable in use. You wouldn't worry about damage even in case it falls down



from one meter high.

- With a inner layer made out of high-stretch material, the X-ray film stick to the screen tightly and equally, the photograph is clear and rich in levels. The inner layer is covered by cloth, so it is very convenient to change the screen is and without damage to the inner layer.

Medical Computer Interphone System

Brief introduction

- Medical computer interphone system has adopted the most advanced microcomputer
- special chip. The main line communication preparation and ease lead to unending calling.
- Its multiple functions and performances have achieved the creation of this line in our country.
- It is an easy way for the nurse to communicate with the patient and know about the situation
- in the sickroom so that the efficiency and the grade of the hospital can be raised.



X-ray Film Hanger

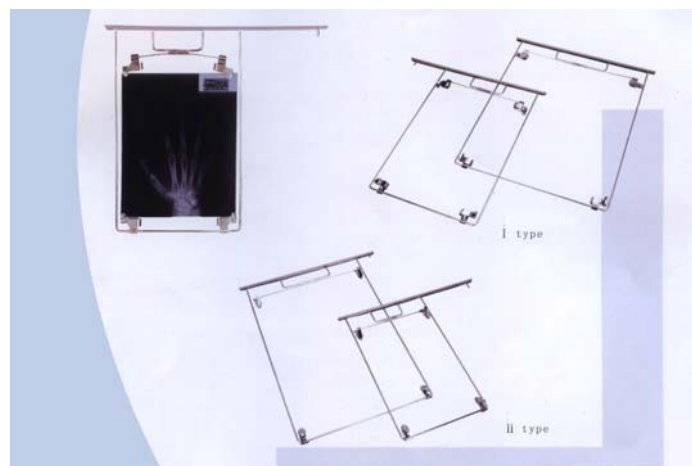

X-ray Film Safety Light

Brief introduction

- The X-ray film safety light has special light-filtered plate,
- it is suitable for use in a darkroom during the processing of
- blue-sense and green-sense X-ray films.
- The light is installed with a 15W common light bulb, of which
- the working voltage is 220V. The circuit is finely-designed and
- there are two types for your favor, one is the standard type and
- the other is light-adjustable. It has the characteristics of
- having a wide scope of application, and being easy to install
- and superb in design. It is an ideal illuminating device for a
- darkroom during film processing.



Chart Light Box

Brief introduction

- This product is suitable for the checking of myopia and hyperopia in school, hospital and other relevant departments.
- The front frame of the visual chart is made of high-strength aluminum alloy, matched with highly-clear board of the visual signs. The box body is wholly made of high-quality steel plate and is of static spray coating. It is superb in design and durable to use. The visual signs are in great contrast and highly clear, ensuring an exact checking result.
- A fluorescent lamp is the light source. The light box is equipped with an electronic ballast. It can function normally under low voltage, with steady illumination and no flash. Maintenance is simple. By opening up the front frame, circuit checking and fluorescent lamp changing can be done right away.

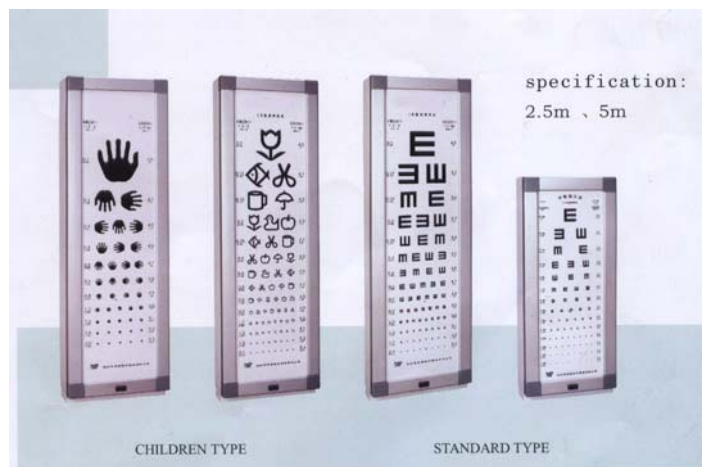

-
- The light box has two specifications of testing distances: 2.5m and 5.0m.

Intensifying Screen



Container For Film Development



